

“service,
strength and
quality”

THISTLE GROUP



Multi-purpose winch with small footprint.
Line pull up to 7,500kg and 400 meter rope capacity.
Winch suitable for a variety of purposes, conforms to ISO 4301/1.

7,500 kg
Hoisting &
Recovery
Multi-Purpose
Winch



Key Points:

- Small footprint
- Suitable for subsea use
- Gearbox mounted inside drum
- Multi-disk brake
- Marine paint system
- Foot mounted
- Parker Hannifin Motor

Available Accessories:

- Grooved drum
- Drum RPM counter
- Rope winding control
- Cable gland

Technical Data	
Line Pull Capacity (4th Layer):	7,500 kg
Drum Capacity:	400 m
Advised Rope Diameter	20 mm
Rope Speed (Top Layer):	43 m/s
Static Holding Torque:	600 Nm
Operating Pressure:	260 Bar
Maximum Oil Flow Rate:	220 LPM
Weight (empty):	580 kg

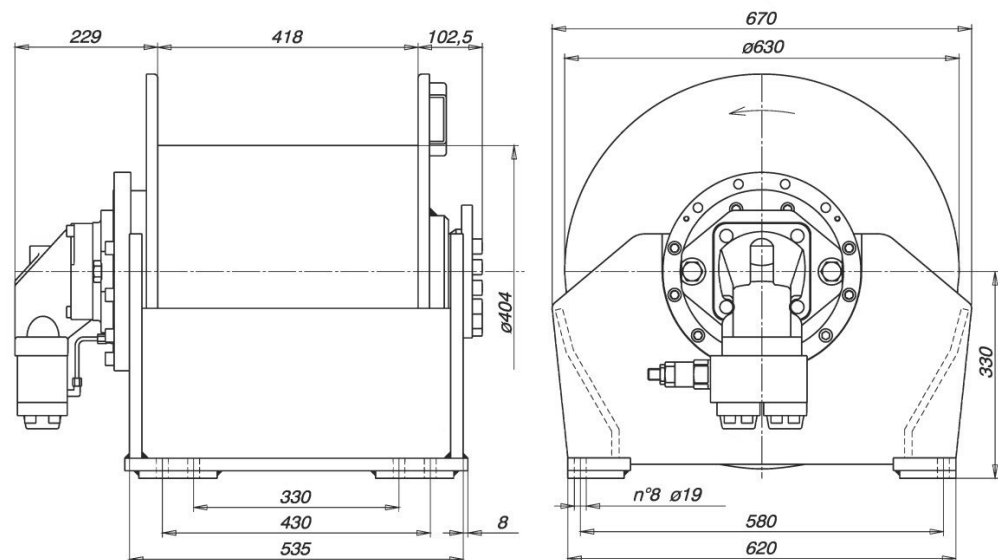

THISTLE GROUP HQ
5 Baltic Place, Peterhead,
Aberdeenshire, Scotland,
AB42 1TF
Tel: +44 (0)1779 477 210
sales@thistlemarine.co.uk
www.thistlegroup.co.uk